

ROTALIGN[®] Ultra **iS**

The Alignment **i**ntelligent **S**ystem

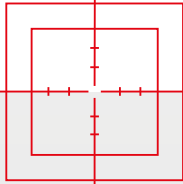

We care about your assets



Present in all industries

PRÜFTECHNIK Alignment Systems, the inventor of laser alignment, has many decades experience developing, manufacturing and applying laser-based alignment systems.

Our measurement systems are used in alignment applications for rotating machinery within all industries.



Our precision is your benefit

40 years' experience in making your machines run better



Extend machine availability and efficiency

Precision alignment pays

Rotating machinery is susceptible to misalignment. Machines should be well aligned at the commissioning stage and thereafter regularly maintained. This increases the mean time between failures (MTBF) effectively resulting in high savings in maintenance costs.

Laser precision alignment extends machine availability and protects assets while increasing product quality as vibration is reduced to very low levels.

Precision alignment guarantees

- ▶ Reduced energy consumption
- ▶ Reduction in bearing, seal, shaft and coupling failure
- ▶ Reduced bearing and coupling temperatures
- ▶ Reduced vibration
- ▶ No breaking (or cracking) of shafts
- ▶ Secure foundation bolts

Advantages of laser shaft alignment

Single laser technology shaft alignment systems from PRÜFTECHNIK take hundreds of readings, with the highest accuracy and simplicity, making it possible to perform measurement in all conditions.

- ▶ User-friendly and intuitive
- ▶ Accurate and precise
- ▶ Take unlimited readings at any desired position
- ▶ Measurement repeatability check through a unique measurement table
- ▶ Simultaneous live monitoring of machine corrections in vertical and horizontal directions
- ▶ Documentation and professional reports

ROTALIGN® Ultra iS –

the ideal solution for all requirements

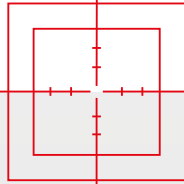

Achieve your objective with
intelliSWEEP® in three simple steps



1. Enter dimensions



2. Rotate shafts



3. Display alignment status

Live Trend

The monitoring function is used to analyze thermal or process-related machine positional changes during run-up and coast down phases, at the same time recording machine vibration.

Vibration Acceptance Check

The vibration check following the alignment ensures that the machine can be operated without restrictions. No additional accessories are required with ROTALIGN® Ultra iS.



ROTALIGN® Ultra iS – iS stands for 'intelligent System' – is a modular platform for a wide range of applications. ROTALIGN® Ultra iS is a combination of ROTALIGN® Ultra and the intelligent sensALIGN® sensor and laser.



RFID machine identification

A RFID reader and tag uniquely identify the machine; basic data is read out and written back after the alignment job. Data can be accessed with NFC-enabled smartphones.



Machine train and multiple coupling

Up to five couplings can be measured and aligned simultaneously.



Bore alignment

Ideal for repair and reconditioning of internal combustion engines, piston compressors and pumps and also for alignment of stern tubes. Specially suited for alignment of steam and gas turbines and precision measurement of the internal components of turbines, such as bearing rings, diaphragms, inner shells and casings.

Live Move

Simultaneous live monitoring of machine corrections in vertical and horizontal directions. 'Live Move' can be started with the sensor at any angular position.

Geometric applications

Accurate measurement of straightness, surface flatness, levelness, parallelism and perpendicularity.

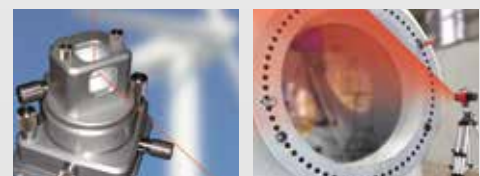

ROTALIGN® Ultra iS – the Alignment intelligent System

Real time measurement quality

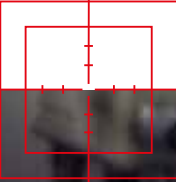

Measurement - IntelliSWEEP
Current file name: PLANT 2
Laser centred
18.1° 18.3°

Measurement - IntelliSWEEP
Current file name: PLANT 2
Laser centred
344.8° 344.8°

Measurement - IntelliSWEEP
Current file name: PLANT 2
Laser centred
301.9° 301.9°

Measurement - IntelliSWEEP
Current file name: PLANT 2
Laser centred
264.7° 265.1°

	Vertical	Horizontal
Quality	100%	100%
Rotation	135°	135°
Readings	291	291

Measuring... Rotate the shaft, press Enter to stop measurement.

Measurement Quality
Current file name: PLANT 2
Mode: IntelliSWEEP

Criteria	Current
1. Rotation angle	100%
2. Ellipse standard deviation	90%
3. Environmental vibration	50%
4. Rotation axes	80%
5. Angle rotation inertia	80%
6. Rotation direction	100%
7. Rotation speed	90%
8. Filter output	94%
Total	100%

Use Menu button to check screen options.

As shafts are rotated, the attained measurement quality is clearly displayed on the screen – a green or blue sector signifies good measurement data.

Quality factors are calculated from the innumerable values recorded while measuring. Users receive detailed information on the quality of the measurement data.

100% Precision – 0% Error

sensALIGN® on-board intelligence

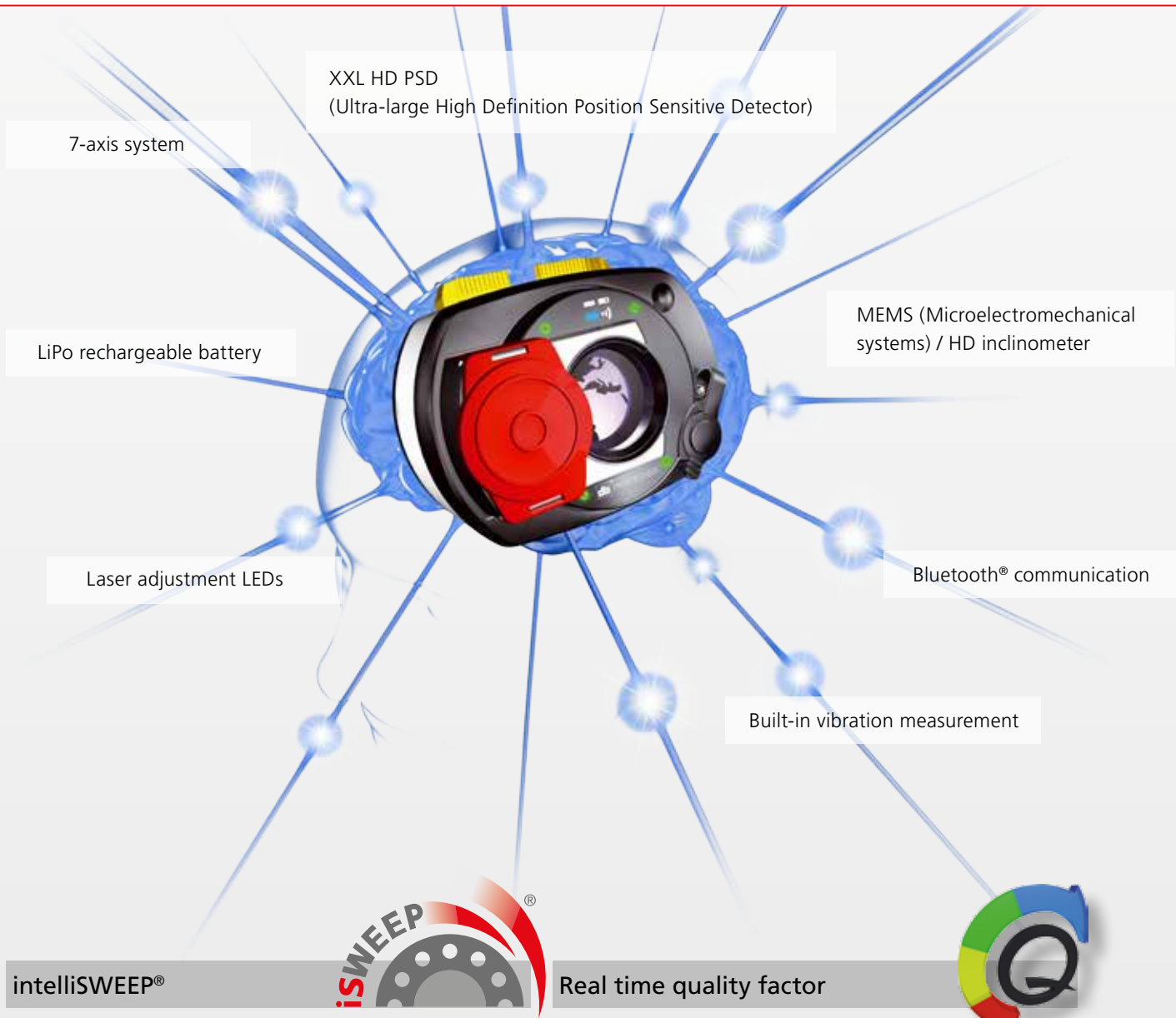

The intelligent intelliSWEEP® HD measure mode actively supports the user by detecting error influences such as coupling play, rotational angle or vibration, and automatically eliminating them.

As shafts rotate, a large number of measurement data is automatically and continuously recorded. This is much more accurate when compared to measurement methods where measurement is taken at three positions only.

The user is kept informed of the quality of the measurement and given hints on how to achieve improved measurement data.

- ▶ Quality factors
- ▶ Rotation angle
- ▶ Ellipse standard deviation
- ▶ Environment vibration
- ▶ Rotation evenness
- ▶ Angle rotation inertia
- ▶ Rotation direction
- ▶ Rotation speed
- ▶ Filter output

"intelliSWEEP®: the new and unique intelligent HD measurement mode that collects and processes hundreds of real measurement points"

sensALIGN® on board-intelligence

Automatically compensates for negative influences

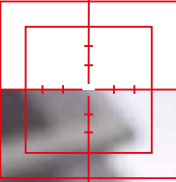

4 adjustment LEDs Initial laser adjustment becomes child's play over any distance. Four green LEDs signal that the laser beam is hitting the centre of the detector.

At a glance

- ▶ **Real time quality by intelliSWEEP**
Always precise, accurate and repeatable
- ▶ **7-axis measurement system with High Definition PSD, XXL detector**
Any amount of misalignment can be easily
- ▶ **In-built vibration measurement**
Measure machine vibration before, during and after alignment, no need for additional hardware
- ▶ **Environmental vibration monitoring**
Accurate shaft alignment under vibrating condition
- ▶ **Precision in-built inclinometer through MEMS**
Used for backlash detection
- ▶ **Communication to the sensor through the laser beam**
sensALIGN® laser information readily available
- ▶ **Integrated class 1 Bluetooth®**
Wireless communication without additional accessories
- ▶ **Rechargeable battery with latest LiPo technology and intelligent power management**
Long runtime without memory effect

sensALIGN® laser

sensALIGN® sensor

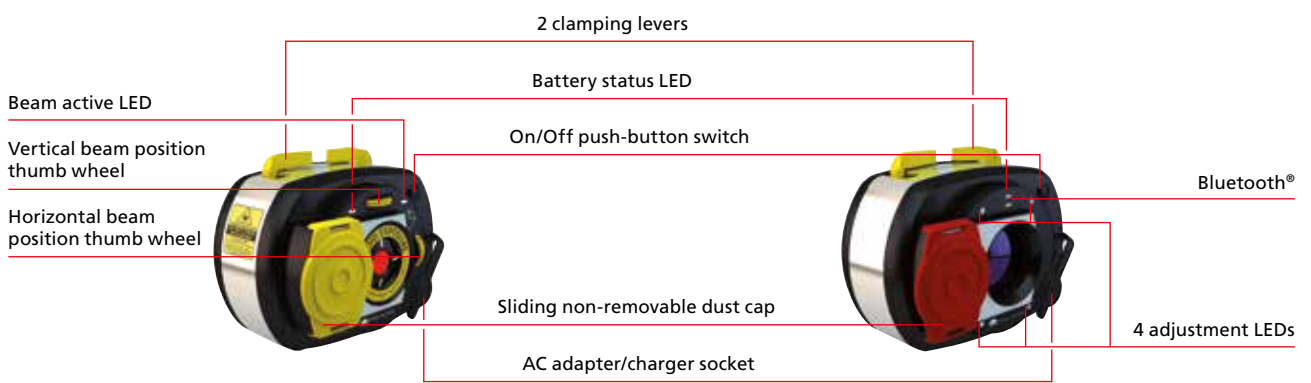

ROTALIGN® Ultra iS – impressive features

Don't miss out on these highlights

7-axis-measurement system with XXL HD PSD

7-axis HD PSD (Ultra-large High Definition Position Sensitive Detector) measurement system provides repeatable precision for any misalignment or large measurement distances.

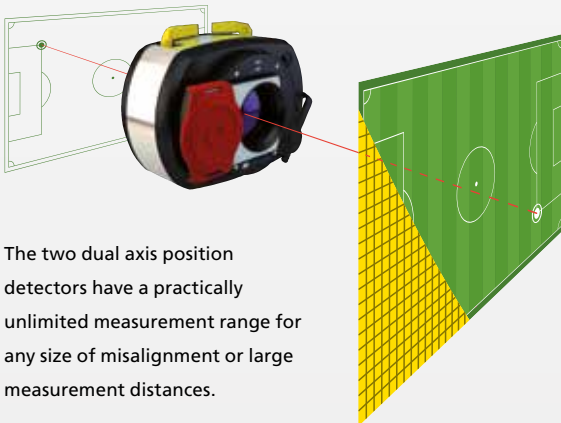

The two dual axis position detectors have a practically unlimited measurement range for any size of misalignment or large measurement distances.

Built-in vibration measurement

- ▶ Check the running machine vibration before and after alignment
- ▶ Environmental vibration monitoring
- ▶ Recording vibration during 'Live trend' measurement

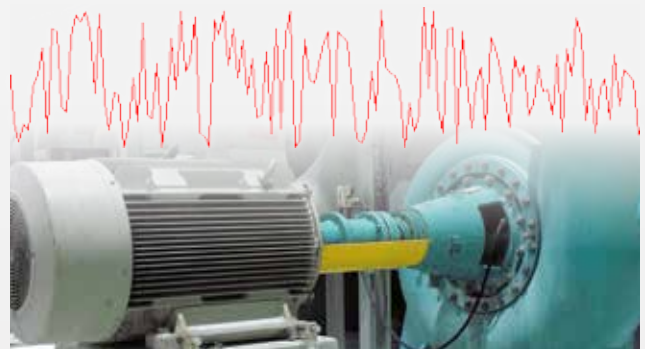

Inclinometer using MEMS

Precision built-in inclinometer using MEMS in both laser and sensor for detection of coupling backlash.

Power management

- ▶ Intelligent power management for laser and sensor
- ▶ Rechargeable battery with latest LiPo technology
- ▶ Long runtime and no memory effect
- ▶ Battery interchangeable between sensor and laser
- ▶ Laser and sensor can be powered through the computer

Communication/data transmission

Communication to the sensor through the laser beam: intelligent laser data streaming e.g. angle and battery status.

Integrated class 1 Bluetooth® wireless communication without additional accessories.



Any information available at any time

ROTALIGN® Ultra iS analysis tools

Tools to enhance machine alignment condition

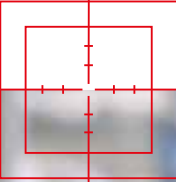

Soft foot wizard



Soft foot analysis is simplified with a diagnostic tool.

Editable ellipse

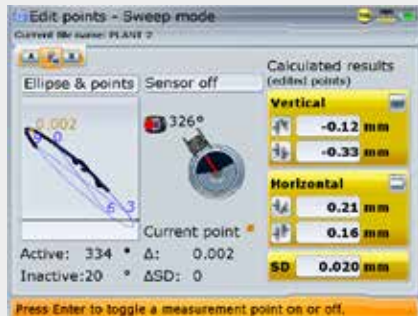

Allows editing of raw measurement data and the analysis of the alignment conditions.

Thermal growth calculator



Used to determine the machine expansion parameters mathematically.

Move Simulator

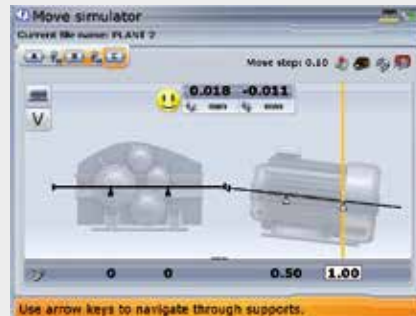

Simulates shim values and horizontal movement corrections.

Measurement table, standard deviation

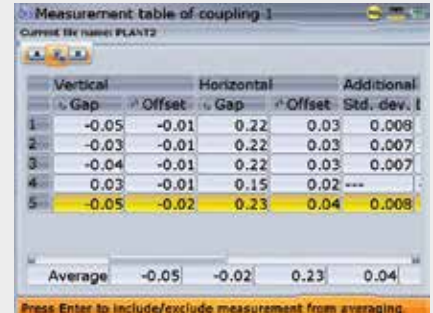

It allows the quality and repeatability of measurements to be determined precisely.

Customized tolerances



The user can set customized tolerances for improved evaluation of the alignment conditions.

Templates (examples)

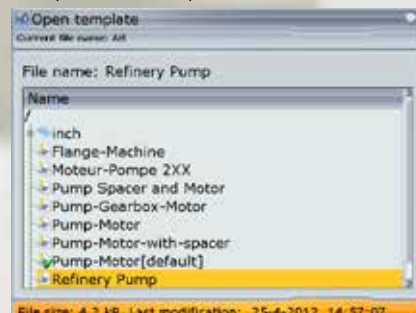

Open the appropriate assembly from a list with a wide range of different machines ...



... or save a machine assembly that is commonly used in your organization.

Coupling play



Detection and suppression of coupling play.



Alignment Center PC Software

Document your job the most convenient way

ALIGNMENT CENTER

This PC software platform is used for all PRÜFTECHNIK Alignment instruments and applications. It is the perfect solution for preparing, analyzing, organizing and archiving measurement files. All alignment and measurement specifications including thermal growth compensation, alignment presets and tolerances are saved for future use. The files can be transferred from the PC to the instrument and vice versa. The software is also used for professional reporting capabilities.

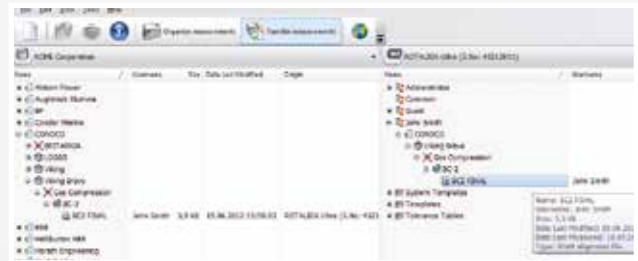

Organize files in a tree structure with unlimited hierarchy.

Set-up

- Create user-specific templates to suit the measurement job
- Set up file information to include file and user names, company, plant, area and machine train
- Prepare file in advance on a PC and transfer to the instrument via the two-way communication

Archiving

- Create a backup of measurement files
- Restore files saved in the backup
- Organize files in a tree structure with an unlimited hierarchy
- Any type of document can be stored in the tree structure
- Comprehensive database search
- Ability to import and export data
- Management of measurement files and any other file type

Analysis and Reporting

- Display results in either 2D or 3D graphics depending on the application
- Evaluate results using the measurement table
- Customise measurement reports to include company information and logo
- Simulate measurement results by entering manual values
- Optimize alignment by redefining fixed feet
- User-defined tolerances
- Conversion of dial gauge readings

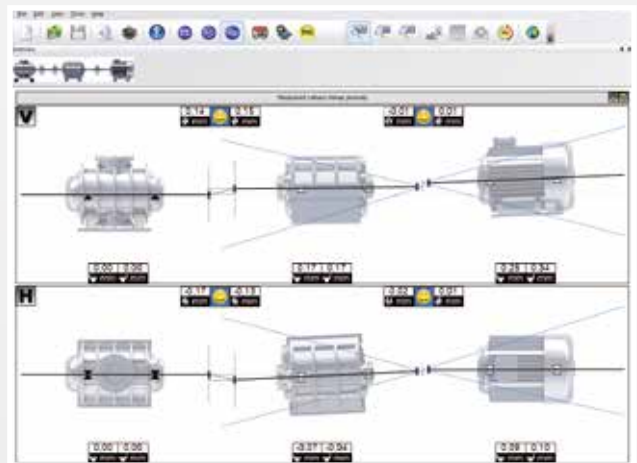

Graphic display of measurement results.

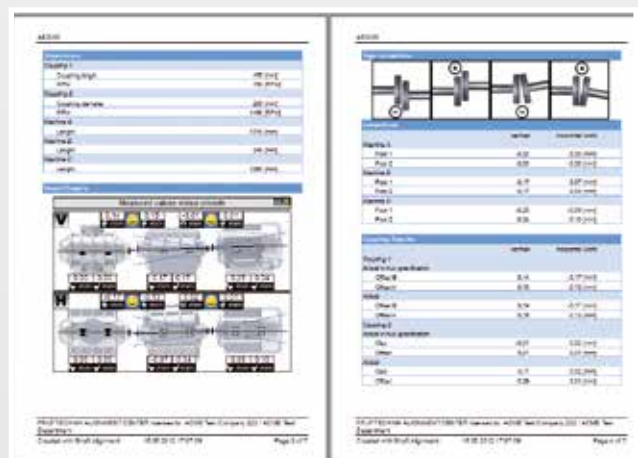

Customized professional reports (example).



Quick steps to perfect machine alignment

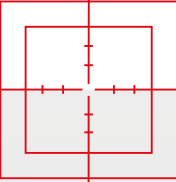

PREPARATION



Identification of the machine

Use the RFID reader for clear identification of machine to be aligned – all at the press of a button.



Mounting

Sensor and laser mounted on the shafts using the compact chain type bracket or the magnetic bracket.

MEASUREMENT AND ALIGNMENT



Measurement

Hundreds of measurement points are collected and transmitted wireless to the computer.

CONFIRMATION



Vibration measurement

The good alignment should be confirmed by reduced vibration values.



Save

Updated machine data and alignment status are recorded on the RFID tag.



Adjustment of the laser beam

The four adjustment LEDs make centring the laser beam child's play.



Enter dimensions

The necessary sensor and machine foot dimensions are quickly inputted.

UMENT



Vertical and horizontal alignment correction

Simultaneous live monitoring of machine corrections in vertical and horizontal directions.

PERMABLOC® shims in appropriate sizes simplify the process of raising or lowering the machine.

CONCLUSION – the machine runs smoothly again



Three packages: Standard – Advanced – Expert

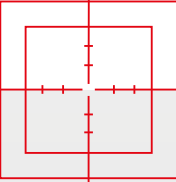

Standard

High resolution color backlit TFT screen – 145 mm/ 5.7 inch diagonal and backlit alphanumeric keyboard
USB interface for PC and printer
Heavy-duty Li-Ion rechargeable battery
Rigid pre-assembled universal brackets and additional support posts included in a pouch
UniBeam – patented single laser-sensor technology for quick laser adjustment
Integrated electronic inclinometer
Alignment of horizontal, vertical and flanged-mounted machines
Alignment of coupled / non-coupled and rotatable / non-rotatable machines
Alignment of cardan and spacer shafts (cardan requires a special bracket)
Machine train alignment up to 6 machines
Soft foot measurement and correction
User-defined tolerances
TolChek® – automatic evaluation of alignment condition with 'Smiley' and LEDs
Variety of measurement modes: SWEEP, Static, Multipoint and Dial gauge inputs
InfiniRange® extends detector measurement range to handle gross misalignment
Live monitoring of horizontal and vertical corrections – Live Move
Move simulator
Static feet selection to resolve base-bound and bolt-bound problems
Realistic machine graphics which can be designated
Save thousands of measurement files in the device
Save reports as PDFs directly to memory stick
Data protection - auto save and resume capability
In compliance with IP 65 classifications
PC display for presentations/training in customer premises
Platform prepared for other alignment applications like Straightness, Flatness and Bore concentricity measurement
RFID Machine Identification

ROTALIGN® Ultra iS is based on a three-level system. The basic Standard version is packed with powerful features that include the Move Simulator and user-defined tolerances. This version is easily upgradable to the Advanced version to include the intelligent features and the powerful analysis tools. The system can be extended to the Expert level by adding 'Live Trend' and/or the multiple coupling application.

Advanced

Intelligence features
Vibration acceptance check without extra accessories
Live simultaneous Move in both horizontal and vertical directions
Soft foot wizard
Machine train up to 14 machines
Measurement Pass mode
Standard Deviation
Editable ellipse
Thermal growth calculator
Under/over-constrained feet
File/Machine templates
Vector tolerances
History table

Expert

'Live Trend' with magnetic or permanent fixation brackets
Multiple coupling measurement



Optional: Shims and mounting brackets for different applications.

Technical data



sensALIGN® sensor

CPU and memory	ARM Cortex™ M3 and 2GB Flash memory
Environmental protection	IP 65 (dustproof and water jet resistant), shockproof
Relative humidity	10% to 90%
Ambient light protection	Optical and active electronic digital compensation
Operating temperature	-10°C to 50°C
Measurement range	Unlimited, dynamically extendible (U.S. Pat. 6,040,903)
Measurement resolution	1 µm
Measurement error	< 1.0%
Vibration measurement	mm/s, RMS, 10 Hz to 1 kHz, 0 mm/s – 5000/f • mm/s ² (f in Hertz [1/s])
Inclinometer resolution	0.1°
Inclinometer error	± 0.25% full scale
External interface	Integrated Bluetooth® Class 1 wireless communication, RS232, RS485, I-Data
LED indicators	4 x LED for laser adjustment, 2 LEDs for Bluetooth® communication and battery status
Operating time	12 hours continuous use
Power supply	Lithium Polymer rechargeable battery 3.7 V / 1.6 Ah / 6 Wh.
Dimensions	Approx. 103 x 84 x 60 mm
Weight	Approx. 310 g



sensALIGN® laser

Type	InGaAlP semiconductor laser
Beam divergence	0.3 mrad
Environmental protection	IP 65 (dustproof and water jet resistant), shockproof
Relative humidity	10% to 90%
Beam power	< 1mW
Wavelength (typical)	635 nm (red, highly visible)
Safety class and precautions	Class 2, IEC/EN 60825-1:2007 Do not stare into laser beam
Operating temperature	-10°C to 50°C
Inclinometer resolution	0.1°
Inclinometer error	± 0.25% full scale
LED indicator	2 LEDs for battery status and laser transmission
Operating time	70 hours continuous use
Power supply	Lithium Polymer rechargeable battery 3.7 V / 1.6 Ah / 6 Wh.
Dimensions	Approx. 103 x 84 x 60 mm
Weight	Approx. 330 g



ROTAGLIGN® Ultra iS technical data

CPU	Mavell XScale Processor running at 520 MHz
Memory	64 MB RAM, 64 MB Internal Flash, 1024 MB Compact Flash Memory
Display	Type: Transmissive (sunlight-readable) backlit TFT color graphic display Resolution: Full VGA, 640 x 480 pixels; Dimensions: 145 mm / 5.7 inch diagonal Keyboard elements: navigation cursor cross with up, clear and menu keys; Alphanumeric keyboard with dimensions, measure and results hard keys
LED indicators	4 LEDs for laser status and alignment condition 2 LEDs for wireless communication and battery status
Power supply	Operating time: 25 hours (using Li-Ion rechargeable battery) 12 hours (using disposable batteries) typical use (based upon an operating cycle of 25% measurement, 25% computation and 50% 'sleep' mode) Lithium-Ion rechargeable battery: 7.2 V / 6.0 Ah Disposable batteries: 6 x 1.5 V IEC LR14 ("C") [optional]
External interface	2 x USB host for printer, keyboard or PC communication 1 x USB slave for printer, keyboard or PC communication RS232 (serial) for receiver I-Data socket for receiver Integrated Bluetooth® wireless communication, Class 1, transmitting power 100mW AC adapter/charger socket
Environmental protection	IP 65 (dustproof and water spray resistant), shockproof Relative humidity 10% to 90%
Temperature range	Operation: 0°C to 45°C [32°F to 113°F] Storage: -20°C to 60°C [-4°F to 140°F]
Dimensions	Approx. 243 x 172 x 61 mm [9 9/16" x 6 3/4" x 2 3/8"]
Weight	1 kg (without battery)
CE conformity	EC guidelines for electric devices (2004/108 EEC) are fulfilled

ROTAGLIGN® Ultra iS case

Contents may vary
depending upon
package ordered



Service and customer support

Come with us to the next level of alignment systems

Quality of service

The PRÜFTECHNIK high-tech lab is the heart of our development. Sensors, lasers and new systems are developed, tested and produced to the highest quality every day.

Because we care about the quality of our products and our customers needs, we have established service centres worldwide to ensure that customers have precision alignment available to them at all times.

Customized product training

Training and seminars are presented by a professional team and are intended to support professional users with the application of the systems and to familiarise them with alignment applications in depth.

Machinery service

PRÜFTECHNIK provides a full range of high-end alignment services. Our dedicated machinery service experts assist you in the overhaul of large and complex machinery as well as with large-scale alignment projects such as the construction and installation of new turbines. Our services include shaft alignment, monitoring of positional changes, geometric alignment and turbine alignment.



PRÜFTECHNIK consists of the following business areas



Alignment Systems



Condition Monitoring



Nondestructive Testing



Service & Support

ROALIGN®, sensALIGN®, iSWEEP®, intelliSWEEP®, TolChek® and InfiniRange® are registered trademarks of PRÜFTECHNIK Dieter Busch AG. No copying or reproduction of this information, in any form whatsoever, may be undertaken without express written permission of PRÜFTECHNIK Dieter Busch AG. The information contained in this leaflet is subject to change without further notice due to the PRÜFTECHNIK policy of continuous product development. PRÜFTECHNIK products are subject to patents granted or pending throughout the world. ISO 9001:2008 certified. © Copyright 2015 by PRÜFTECHNIK Dieter Busch AG.



PRÜFTECHNIK
Condition Monitoring GmbH
Oskar-Messter-Str. 19-21
85737 Ismaning, Germany
Tel.: +49 89 99616-0
Fax: +49 89 99616-200
info@pruftechnik.com
www.pruftechnik.com
A member of the PRUFTECHNIK group